

Full lift safety valve with spring loading. (AIT)



Free blow-off
Directed blow-off

Model 595
Model 695



The valve works as an automatic pressure releasing regulator activated by the static pressure existing at the entrance to the valve and is characterized by its ability to open instantly and totally.

Design in line with the "AD-MERKBLATT A2 Specifications sheet" and "BS 6759 : Part 2 : 1984 Specification for safety valves for compressed air or inert gases".

Complies with the requirements of "Regulation for pressurised equipment ITC - MIE - AP 17 4.1.".

Component test stamp: TÜV Rheinland (German technical supervision authority).

Licence N°:

PENDING
ALLOCATION

Specifications

- Model AS without manual discharge operation.
- Model AV with hand wheel threaded to the body and fastened to the shaft which allows immediate manual operation.
- Activated by direct action helicoid spring.
- Simplicity of construction ensuring minimum maintenance.
- Internal body designed to offer favourable flow profile.
- Pressed or vulcanised seal with a precise finish which guarantees tightness, even greater than that required by DIN-3230. Sheet 3.
- Great discharge capacity. For liquids typically used with openings similar to proportional safety valves.
- Totally precise open and close.
- All the valves are supplied sealed at the set pressure requested, simulating operational conditions, and are vigorously tested.
- All components are numbered, registered and checked. If requested in advance, material, casting, test and efficiency certificates will be enclosed with the valve.

IMPORTANT

1.- Fluorelastomer (Vitón) seals or PTFE (Teflón), achieving leakage levels less than

$$0,3 \times 10^{-3} \frac{\text{Pa cm}^3}{\text{sec.}}$$

The ranges of application allow certain flexibility although we recommend limiting them to:

RANGE OF APPLICATION FOR THE SEALS					
FLUID	SET PRESSURE IN bar				
	0,2	5,0	8,5	11,5	36,0
Saturated steam	V		T		
Liquids and gases	V (1)			T	
SEALS	TEMPERATURE IN °C				
		ACCORDING TO MANUFACTURERS		RECOMMENDED BY VYC	
		MINIMUM	MAXIMUM	MINIMUM	MAXIMUM
Fluorelastomer (Vitón)	V	-40	+250	-30	+150
PTFE (Teflón)	T	-265	+260	-80	+230

(1) For $d_0=9,75$ and $d_0=13,00$ we recommend restricting the use of Fluorelastomer (Vitón) at 8,5 bar.

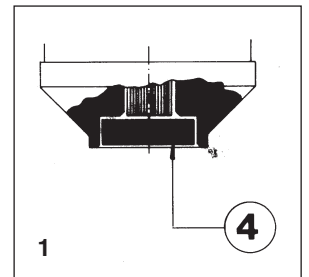

Depending on demand:

- 1.- Buna-nitrils seals, Butyl, Natural rubber, E.P.D.M., Chlorosulphonate polyethylene (Hypalon), Neoprene, Silicone's rubber, etc.
- 2.- Using the discharge deflector prevents:
 - The inconvenience of free discharge.
 - The entry of foreign bodies in the valve which will affect later operation. (Specially designed for moving transport).
- 3.- Possibility of manufacture in other types of material, for use in special working conditions (high temperatures, fluids, etc.).

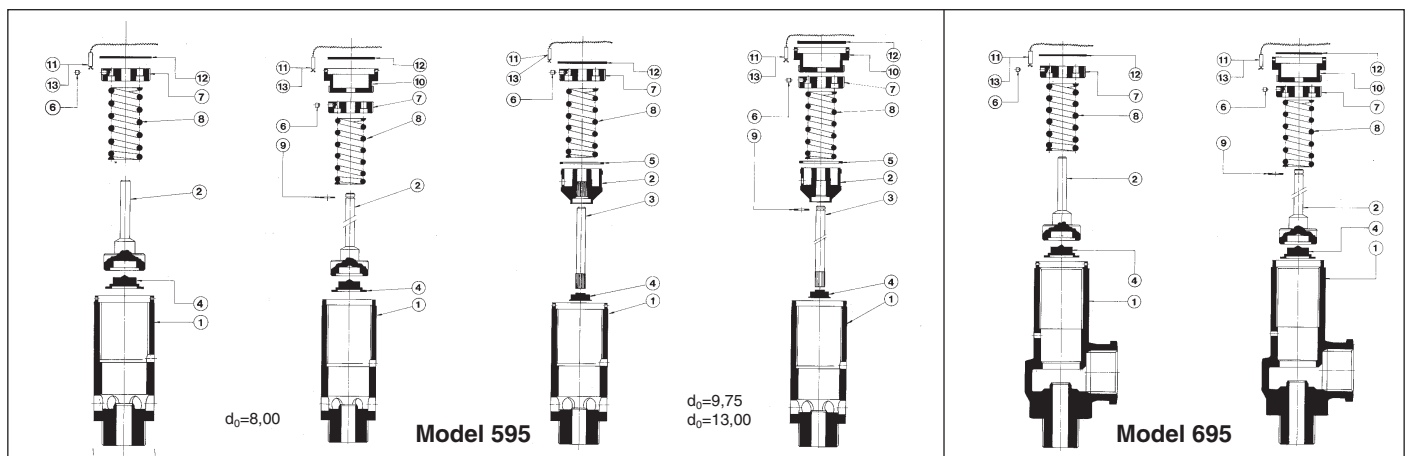
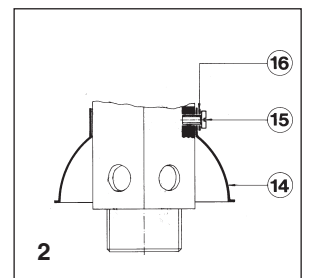

Nº PIECE	PIECE	MATERIAL	
		BRASS	STAINLESS STEEL
1	Body	Brass (DIN-1.7660 CuZn40Pb2)	S. steel (DIN-1.4401) (AISI-316)
2	Plug	Brass (DIN-1.7660 CuZn40Pb2)	S. steel (DIN-1.4401) (AISI-316)
3	Shaft	S. steel (DIN-1.4305) (AISI-303)	S. steel (DIN-1.4305) (AISI-303)
4	Seal	Fluorelastomer (Vitón) PTFE (Teflón)	Fluorelastomer (Vitón) PTFE (Teflón)
5	Limiting ring	S. steel (DIN-1.4310) (AISI-301)	S. steel (DIN-1.4310) (AISI-301)
6	End-stop	Buna-nitril	Buna-nitril
7	Spring press	Brass (DIN-1.7660 CuZn40Pb2)	S. steel (DIN-1.4305) (AISI-303)
8	Spring	S. steel (DIN-1.4300) (AISI-302)	S. steel (DIN-1.4300) (AISI-302)
9	Safety washer	Phosphorous bronze (CuSn6)	S. steel (DIN-1.4568)
10	Hand wheel	Brass (DIN-1.7660 CuZn40Pb2)	S. steel (DIN-1.4305) (AISI-303)
11	Sealing wire	Sealing wire	Sealing wire
12	Characteristic plate	Aluminium	Aluminium
13	Seal	Lead	Lead
14	Deflector	S. steel (DIN-1.4401) (AISI-316)	S. steel (DIN-1.4401) (AISI-316)
15	Screw	S. steel (DIN-1.4401) (AISI-316)	S. steel (DIN-1.4401) (AISI-316)
16	Washer	S. steel (DIN-1.4401) (AISI-316)	S. steel (DIN-1.4401) (AISI-316)
DN		3/8" to 1"	
PN		PMS. 36 bar	40
OPERATING CONDITIONS	PRESSURE IN bar	36	36
	MAXIMUM TEMP. IN °C	205	230
	MINIMUM TEMP. IN °C	-60	-60

MODEL 595													
R ₁	3/8"		1/2"		1/2"		3/4"		3/4"		1"		
CONNECTIONS	Whitworth gas-tight cylindrical male thread ISO 228/1 1978 (DIN-259)												
d ₀	8,00	8,00	9,75	9,75	13,00	13,00							
A ₀ = $\frac{\pi \cdot d_0^2}{4}$	50,27	50,27	74,66	74,66	132,73	132,73							
H	73	76	89	92	113	116							
H ¹	81	84	98	101	123	126							
h ¹	89	92	106	109	132	135							
A	9	12	12	15	15	18							
B	6,00	6,00	9,50	9,50	11,00	11,00							
D	40	40	65	65	65	65							
S	24	24	36	36	42(41) •	42(41) •							
WEIGHT IN Kgs.	AV	AS	AV	AS	AV	AS	AV	AS	AV	AS	AV	AS	
	BRASS	0,22	0,19	0,23	0,20	0,52	0,47	0,56	0,50	0,89	0,81	0,94	0,85
STAINLESS STEEL	0,21	0,18	0,22	0,19	0,49	0,43	0,52	0,47	0,83	0,75	0,88	0,79	
CODE	BRASS 2002-595.	83811	83813	80211	80213	80212	80214	83411	83413	83412	83414	81011	81013
	S. STEEL 2002-595.	83821	83823	80221	80223	80222	80224	83421	83423	83422	83424	81021	81023

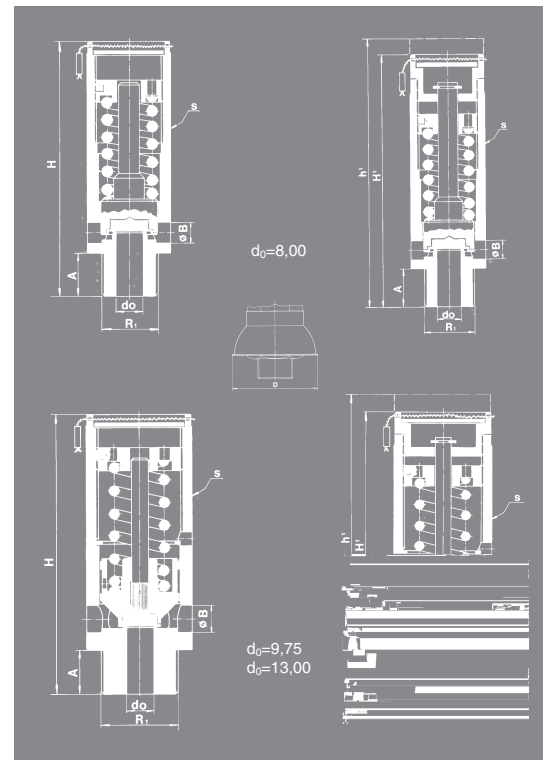

• Stainless steel (DIN-1.4401) (AISI-316).

MODEL 695						
R ₁ x R ₂		3/8" x 1/2"		1/2" x 1/2"		
CONNECTIONS		Male thread x Female thread Whitworth gas-tight cylindrical ISO 228/1 1978 (DIN-259)				
d ₀		8,00		8,00		
A ₀ = $\frac{\pi \cdot d_0^2}{4}$		50,27		50,27		
H		85		88		
H ¹		93		96		
h ¹		101		104		
A		9		12		
L ₁		26		26		
L ₂		32,50		35,50		
WEIGHT IN kgs.	AV	AS	AV	AS		
	BRASS	0,33	0,30	0,34	0,31	
CODE	BRASS 2002-695.	83811	83813	80211	80213	

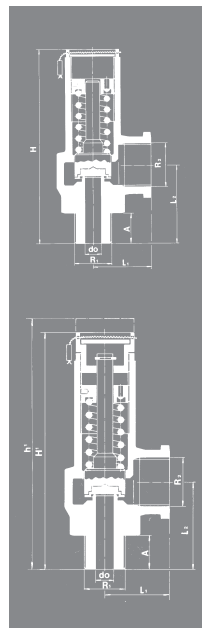

RECOMMENDED RANGES OF APPLICATION						
MODEL		MODEL 595		MODEL 695		
		AS	AV	AS	AV	
FLUID	SATURATED STEAM				*	*
	GASES	INERT	*	*	*	*
		NON INERT			*	*
LIQUIDS				*	*	
OPENING PRESSURE IN % OF THE SET PRESSURE			+10%			
CLOSURE PRESSURE IN % OF THE SET PRESSURE			-10%			

SET PRESSURES AND REGULATING RANGES									
MODEL		695			595				
ENTRY CONNECTION	R ₁	3/8"	1/2"	3/8"	1/2"	1/2"	3/4"	3/4"	1"
EXIT CONNECTION	R ₂	1/2"			-		-		-
	6 x B	-			6 x ø 6,00		6 x ø 9,50		6 x ø 11,00
d ₀		8,00			9,75		13,00		
SET PRESSURE IN bar	MAXIMUM	PMS. 36 bar	36			36		36	
		PN-40	36			36		36	
	MINIMUM	PMS. 36 bar	0,2			0,2		0,2	
		PN-40	0,2			0,2		0,3	
SPRING REGULATING RANGE IN bar	0,20 to 0,70	CODE	56160			56169		56178	
	0,60 to 1,60	CODE	56161			56170		56179	
	1,50 to 3,50	CODE	56162			56171		56180	
	3,40 to 5,50	CODE	56163			56172		56181	
	5,40 to 10,00	CODE	56164			56173		56182	
	9,80 to 15,00	CODE	56165			56174		56183	
	14,50 to 20,00	CODE	56166			56175		56184	
	19,00 to 25,00	CODE	56167			56176		56185	
24,00 to 36,00	CODE	56168			56177		56186		

COEFFICIENT OF DISCHARGE									
MODEL		695			595				
ENTRY CONNECTION	R ₁	3/8"	1/2"	3/8"	1/2"	1/2"	3/4"	3/4"	1"
EXIT CONNECTION	R ₂	1/2"			-		-		-
	6 x B	-			6 x ø 6,00		6 x ø 9,50		6 x ø 11,00
d ₀		8,00			9,75		13,00		
h		2,50			4,00		5,50		
h/d ₀		0,31			0,41		0,42		
COEFFICIENT OF DISCHARGE α _d (1)	SATURATED STEAM GASES	0,68			0,69		0,79		
	LIQUIDS	0,51			-		-		

(1) For set pressures less than 3 bar see graph of discharge coefficient.

pa = Overpressure permitted [bar] absolute.
 p = Set pressure [bar] absolute.
 α_d = Coefficient of discharge.

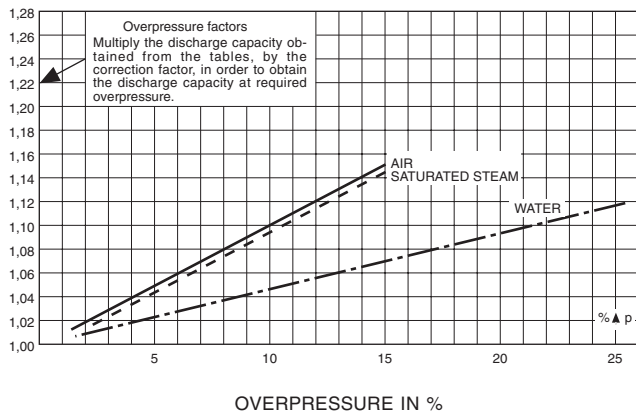
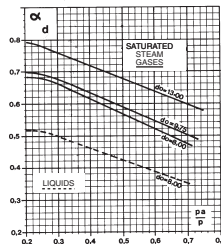
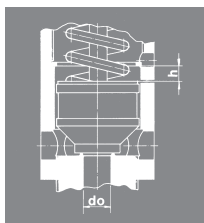

DISCHARGE CAPACITY									
MODEL		695			595				
ENTRY CONNECTION	R ₁	3/8"	1/2"	3/8"	1/2"	1/2"	3/4"	3/4"	1"
EXIT CONNECTION	R ₂	1/2"			-		-		-
	6 x B	-			6 x ø 6,00		6 x ø 9,50		6 x ø 11,00
d ₀		8,00			9,75		13,00		
A ₀ = $\frac{\pi \cdot d_0^2}{4}$		50,26			50,26		74,66		132,73
p [bar]	For other, not so dense liquids, other than water at 20°C apply: $V_L = \sqrt{\frac{p_A}{p_L}} \cdot V_A$ $\delta V_A = V_L \cdot \sqrt{\frac{p_L}{p_A}}$ I - Saturated steam in Kg/h. II - Air at 0° C and 1,013 bar in [Nm ³ /h]. III - Water at 20° C in l/h. V _A = Water flow according to table. V _L = Liquid flow. ρ _A = Water density at a 20° C. (ρ _A = 998 Kg/m ³). ρ _L = Liquid density.								
	SET PRESSURE IN bar	I	II	III	II	II	II		
0,5	20	23	654	23	37	78			
1,0	30	38	1070	38	57	118			
1,5	41	51	1445	51	78	159			
2,0	51	64	1739	64	97	198			
2,5	62	78	2031	78	117	236			
3,0	72	91	2270	91	136	277			
3,5	80	102	2448	102	153	311			
4,0	89	113	2618	113	170	347			
4,5	98	125	2776	125	188	381			
5,0	106	136	2927	136	205	416			
6,0	124	159	3206	159	239	485			
7,0	141	182	3463	182	273	555			
8,0	158	205	3702	205	307	625			
9,0	175	227	3927	227	341	694			
10,0	192	250	4139	250	376	763			
12,0	227	296	4534	296	444	902			
14,0	260	342	4897	342	513	1041			
16,0	293	387	5236	387	581	1180			
18,0		433	5553	433	649	1319			
20,0		478	5854	478	718	1458			
22,0		524	6139	524	786	1597			
24,0		570	6412	570	855	1736			
26,0		615	6674	615	923	1875			
28,0		660	6926	660	991	2010			
30,0		707	7169	707	1060	2150			
32,0		752	7405	752	1128	2290			
34,0		798	7632	798	1195	2427			
36,0		843	7854	843	1264	2565			

Calculus according to "AD-Merkblatt A2".